

Table of Contents

Lab Bench Solutions	2 - 6
Clean Room Solutions	7 - 8
Wall Mount Solutions and Methods	9 - 14
Floor Mount	15 - 17
Tank Solutions	21 - 22
Freezer Farm	23 - 25
OSHPD	26
Custom Fastening Solutions	27
Vivarium	28
UCSD Shake Table Test	29 - 32



The Industry Leader
in Earthquake Fastening.



When you see
This symbol:
Made From
Recycled
Materials



QuakeHold! Industrial
1150 Simpson Way
Escondido, CA 92029
800 959 4053

Lab Bench Solutions

1 - 24" Bar with
3M VHB #4941

2 - Bio-coated 2"
Strap 600lb Rated

3 - 4"x4" Stainless
Steel 316 Clean
Room 500lb Rated

4 - 2"x3" Stainless
Steel 316 Clean
Room 300lb Rated

5 - Bio-coated
Contour Grip for
Curved Equipment

6 - Microscope
Lasso for Extra
Large Units

7 - 2"x3" Thumb
Lock Buckle 300lb
Rated

8 - 2"x2" Thumb
Lock Buckle 200lb
Rated

9 - 1"x2" Thumb
Lock Buckle 100lb
Rated



Multiple Environmental Solutions for Fastening and Securing

800 959 4053
4 Offices to Serve you!



Flex Mount Line Art

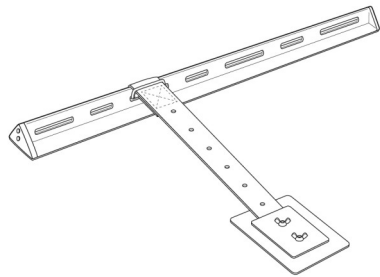

#2

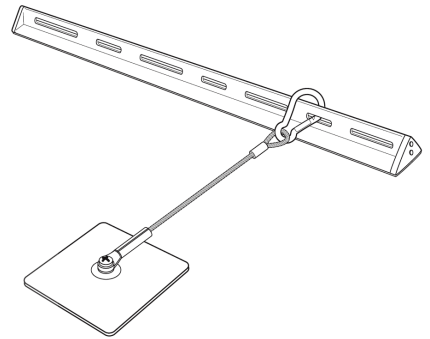

#3

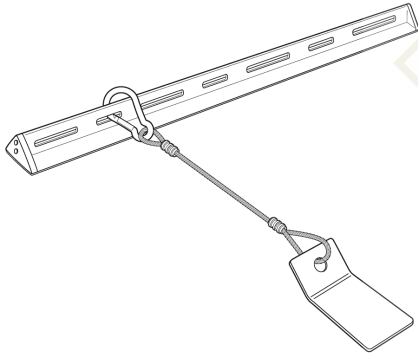

#4

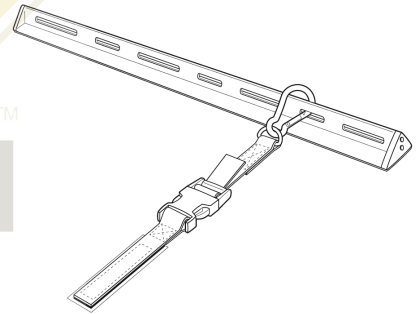

#5

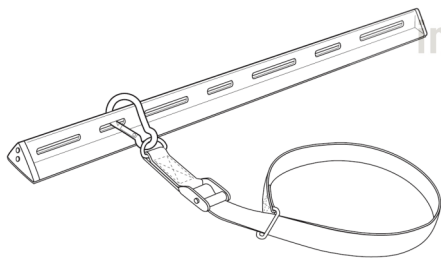

#6

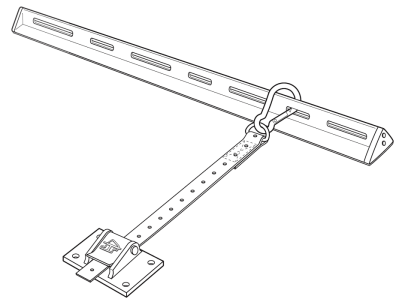

#7

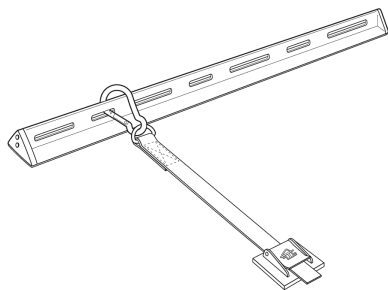

#8

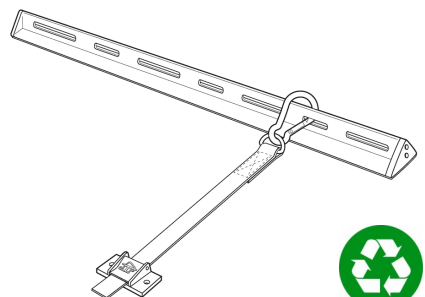

#9



The Industry Leader
in Earthquake Fastening.



Lab Bench Solutions

DOUBLE STACKED HPLC UNIT

Secured by FlexMount Bar, ThumbLock T6 Buckles To Unit Ganged with T4 and Table Secured with Cart-To-Wall Strap

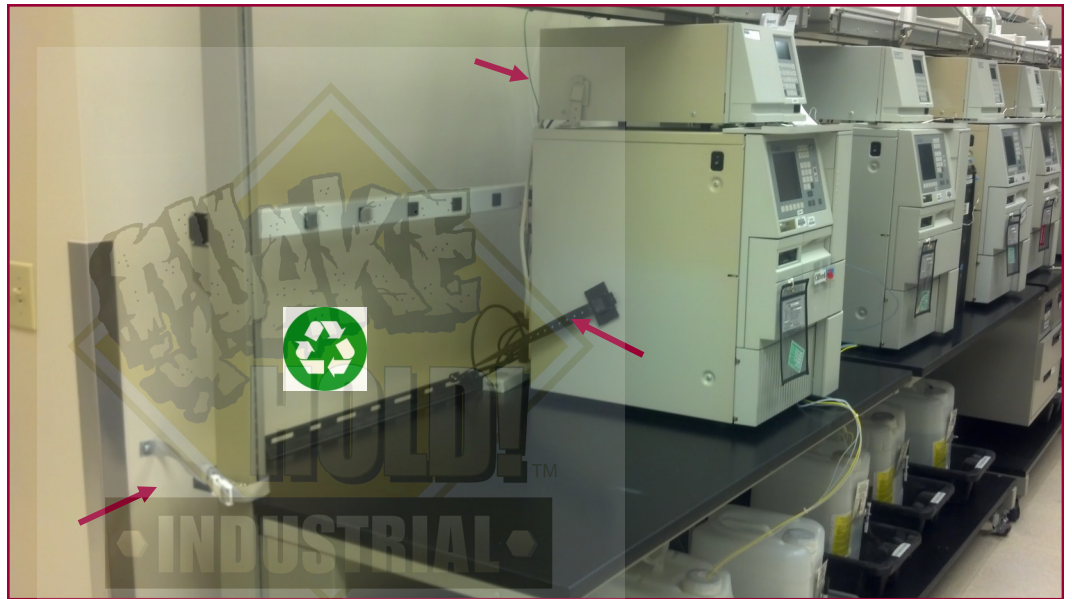

EXTRA LARGE CENTRIFUGE

Secured by FlexMount Bar, 316 Stainless Steel Plates and Cable Assembly

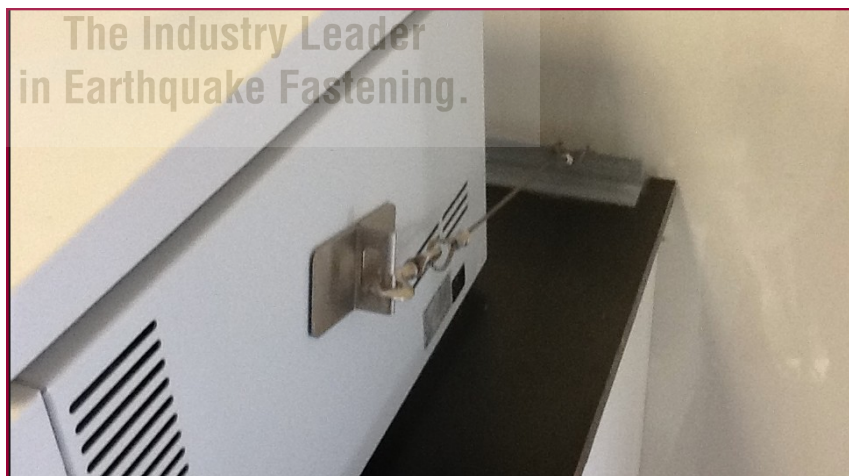

800 959 4053
4 Offices to Serve you!



Lab Bench Solutions

TOP-HEAVY ROBOTS

Secured with Thumb Lock™ Fasteners (4-point attachment)



Color Match Buckles to Countertop.

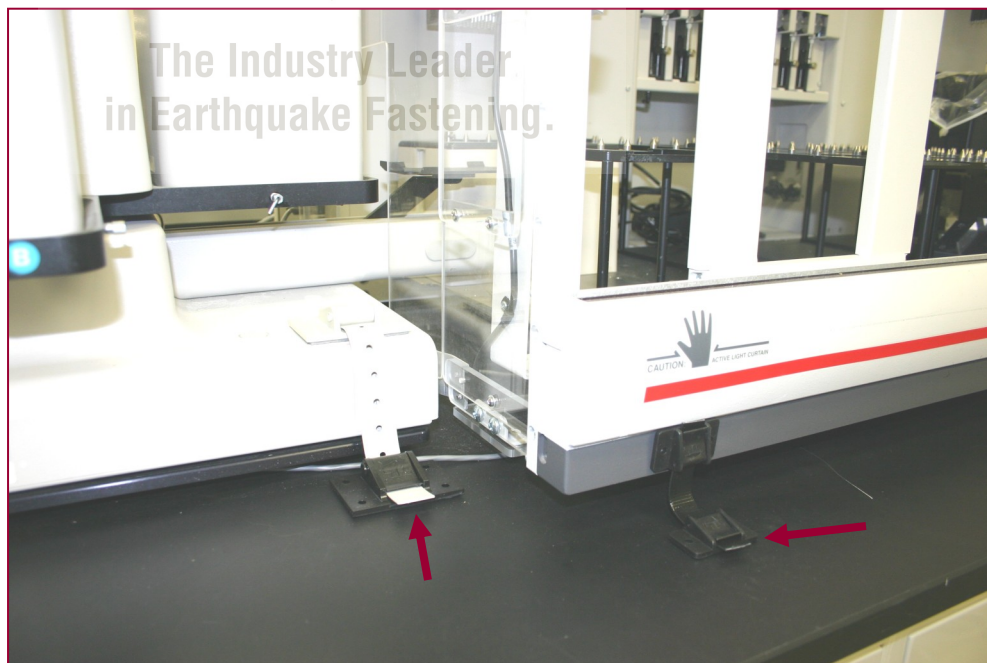

Lab Bench Solutions

**PROTECTING
VALUABLE
ASSETS**

HPLC

Using Patented
Thumb Lock™
Buckle System
To Secure
HPLC

Color match
for HPLC
application.



The Industry Leader
in Earthquake Fastening.

800 959 4053
4 Offices to Serve you!



Clean Room Solutions

316 Stainless Steel with 3M™ VHB (very high bond) Closed-Cell Adhesive in Clean Room Environment



The Industry Leader
in Earthquake Fastening.

Custom Solution To Secure Loose Countertop Shelving On Mobile Racking System

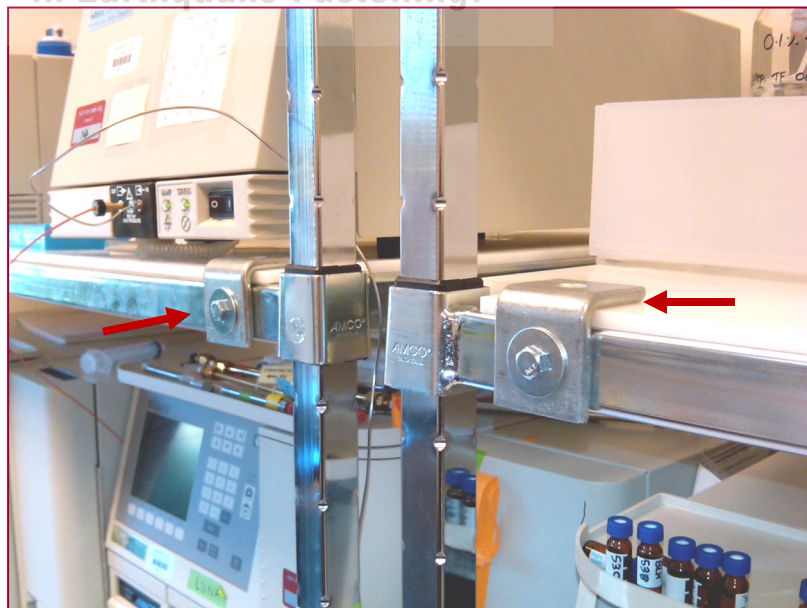

Clean Room Solutions

Large Floor Equipment Secured with 316 Stainless Bracket. All Penetrations are sealed with 100% Silicone



The Industry Leader
in Earthquake Fastening.

4"x6" is the Largest Fastener in the Industry 3M™ VHB Acrylic Adhesive Resists Clean Room Solvents.

800 959 4053
4 Offices to Serve you!



Wall Mount Solutions

USER FRIENDLY

36" of Industrial Velcro™ Adhesive Adhered at a Height of 30" and 60" with a Department of Transportation Rated Seatbelt Closure 4000 lbs

This Innovative Strap Features the Easiest Push Button Disconnect Buckle *Ever* Made.



“The Straps are working great! Everyone likes them. They especially like the one touch quick disconnect in tight spaces.”

Jim Mead, Critical Systems Facilities Engineering, Fred Hutchinson Cancer Research Center, Seattle, Washington



The Industry Leader in Earthquake Fastening.

800 959 4053
4 Offices to Serve you!



Wall Mount Solutions

FLAM, ACIDS, CORROSIVE CABINETS

Straps Are
Adhered In Two
Locations
With Industrial
Velcro™ Barb
Hook And Loop
Fasteners

Strap Is
Secured To
Unistrut Channel
With Quick
Disconnect
Carabineer

Safe Securing
Method for
Flammable,
Corrosives, Toxic
Cabinets - Will
Not Be Pierced

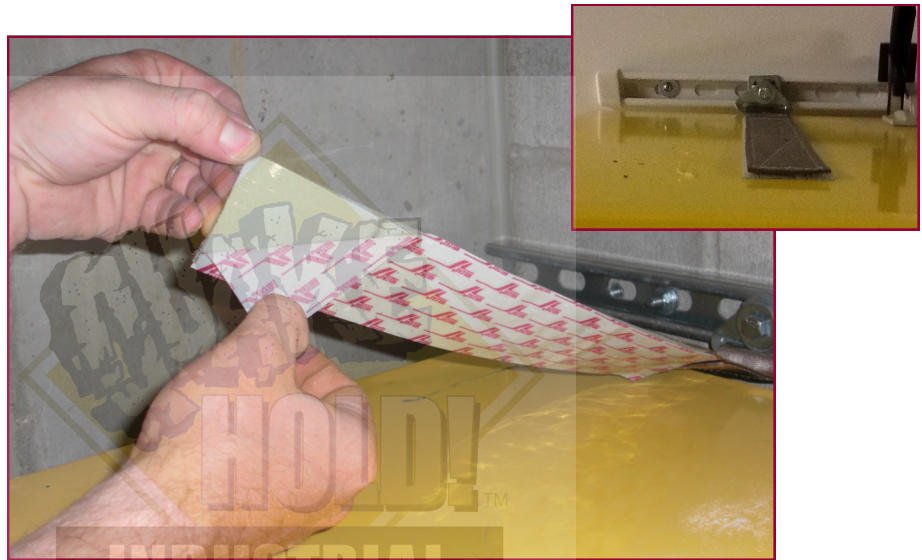

The Industry Leader
in Earthquake Fastening.

800 959 4053
4 Offices to Serve you!



Wall Mount Solutions

REFRIGERATOR

Door Locks Keep Contents Inside

Flips Up To Open

Padlock Optional

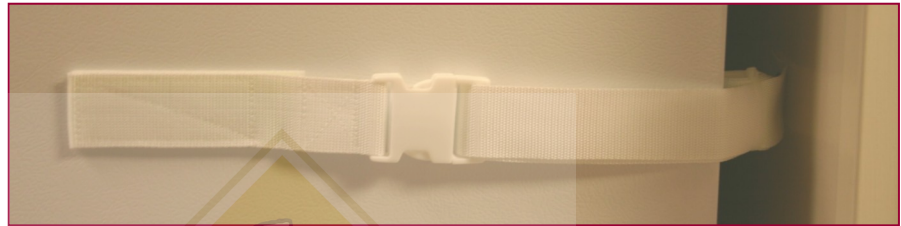

The Industry Leader
in Earthquake Fastening.

Quick
Disconnect
Buckle For Ease
Of Removal

Strap Products
Are Custom
Sewn In Three
Colors.

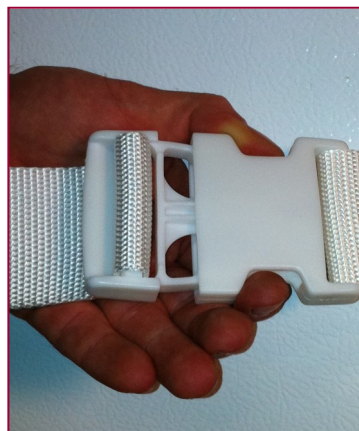

Wall Mount Solutions

METRO AND MOBILE CARTS

Strap Connects To Wall Stud And Shelving And Weaves Through Metro Rack.

Available in Bio-Coated

Cart-To-Wall Securing. Squeeze Buckle To Disconnect.

D-Ring Cinch Around Pole.

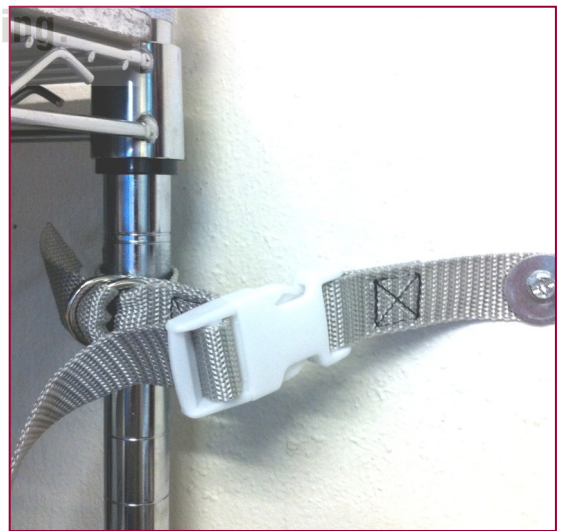

800 959 4053
4 Offices to Serve you!

Wall Mount Methods

Double Strut System Installation

Secured Into Each Metal Stud

Equipment Is Then Secured In Multiple Positions



The Industry Leader
in Earthquake Fastening.

800 959 4053
4 Offices to Serve you!



Wall Mount Methods

INSTALLATION TECHNIQUE FOR STRUT-STRAP SYSTEM

All Installers
Receive Extensive
Training on
Locating Electrical,
Plumbing and
Obstructions in the
Wall.

Installers also
receive Training in
Negative and Posi-
tive Pressure
Rooms.

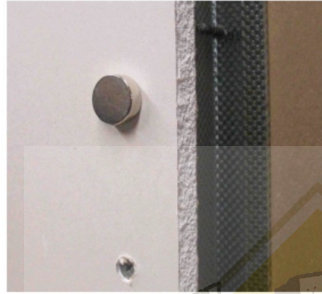

Earth magnet to locate center of stud



Stud finder to verify center of stud



Drill 1/4" hole ending when stud is hit



Look in hole to see if a stud has been hit



Drill 1/2" hole through stud

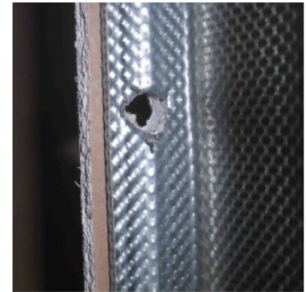

1/2" hole through stud (inside view)



Push Toggler through hole

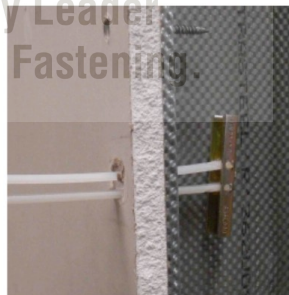

Spread Toggler

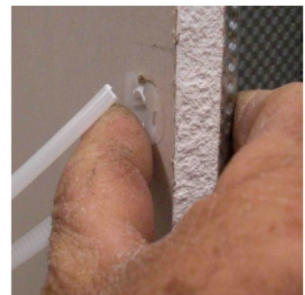

Break Toggler Stems

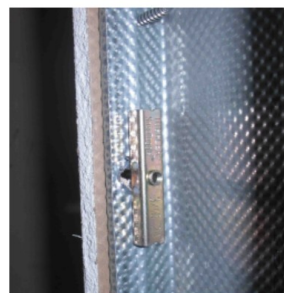

Toggler secured behind stud



Ready for mounting

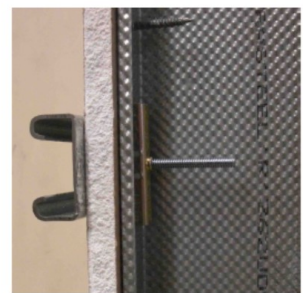

Mount item to wall

Floor Mount Solutions

**OSHPD
ENGINEERED
METHOD FOR
THERMO LINE
OF 14 ULT
FREEZERS**

Custom Sewn
Ratchets Tested
To 4,000 Pound
Break Strength

Engineering For
Single Ratchet For
Smaller Units And
Double Ratchet For
Large Freezers

Stainless Steel
Nested Plates With
Cable To Floor
Using Hilti Drop
Anchors

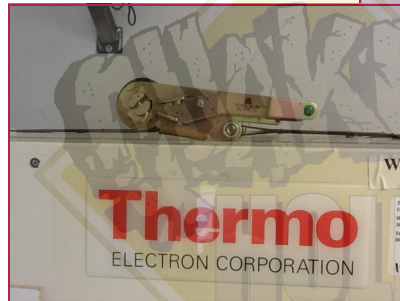

The Industry Leader
in Earthquake Fastening.



Floor Mount Solutions

Stainless Braided Cable Wrapped Around Leg To Carabineer. Also Available In Coated Cable Or Stainless Closed Link Chain



4x4 Stainless 316 Plate With 3M™ VHB Adhesive Secured With Cable Assembly



800 959 4053
4 Offices to Serve you!



Floor Mount Solutions

Custom Floor
Brackets For
Adjustable Feet

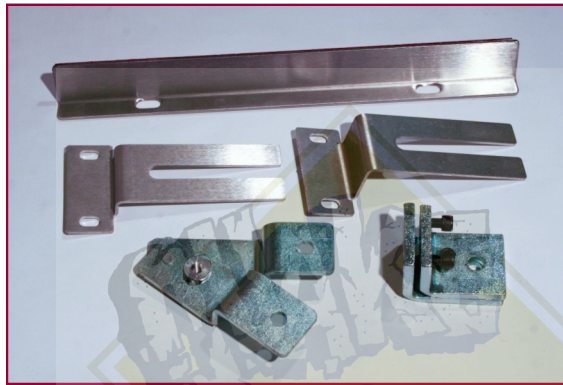

Custom Design
Engineering
and Fabrication

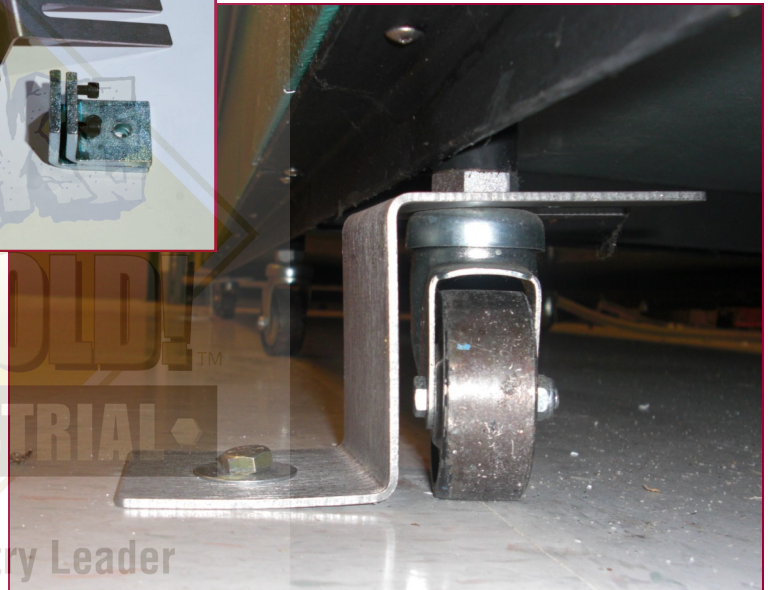

The Industry Leader
in Earthquake Fastening.

Corner Trap
For Equipment
Legs or
Medium Sized
Box Equipment



800 959 4053
4 Offices to Serve you!



4 Open Shelf Solutions

OPTION 1
Stretchable Shock Cord Pull Down Access See-Through Net

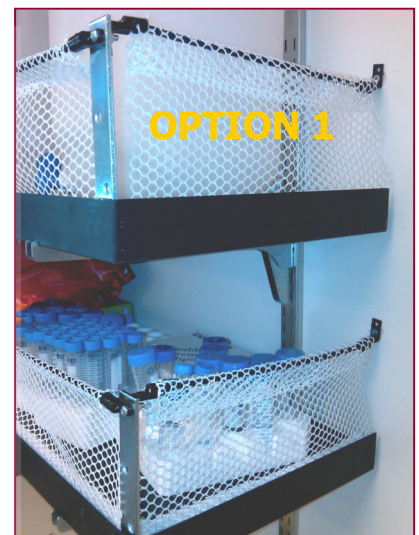

OPTION 2
Book-Keeper Bar Lift and Release Bar



OPTION 3
Double Quick Disconnect Buckles with Netting. Allows Full Shelf Access.



OPTION 4
Single Quick Disconnect Buckles with Nylon Strapping. Allows Full Shelf Access.

Custom Tank Solutions

**LIQUID
NITROGEN
TANKS**

**TANK
CORRAL**
Allows for
Mobility and
Security

**DOUBLE
STRUT TO
WALL**

With Closed
Link Stainless
Steel Chain
and
Carabineer

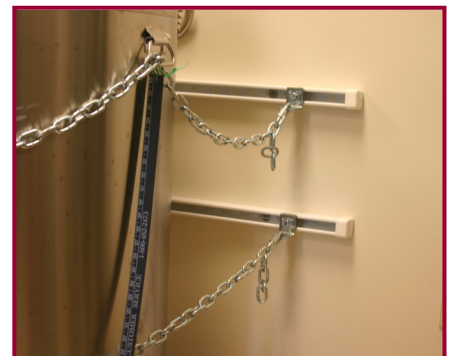

Custom Tank Solutions

MOBILE FERMENTER TANKS

Structure Built
On-Site to
Accommodate
Rolling Storage
Tanks



Heavy-Duty
Engineered
Structural
Bracing



800 959 4053
4 Offices to Serve you!



Freezer Farm Solutions

Most Flexible
Relocation
Method
**THE STRUT
STRAP
SYSTEM**

Pictured Here Are
Two-Tiers Of Pow-
der Coated Wall
Strut Installed Into
Metal Wall Studs

System Allows For
Ease Of Removal
For Servicing and
Relocation Up and
Down The Wall

System Does Not
Require Floor
Drilling and is The
Most Flexible and
Widely Used
Method In
Laboratories.

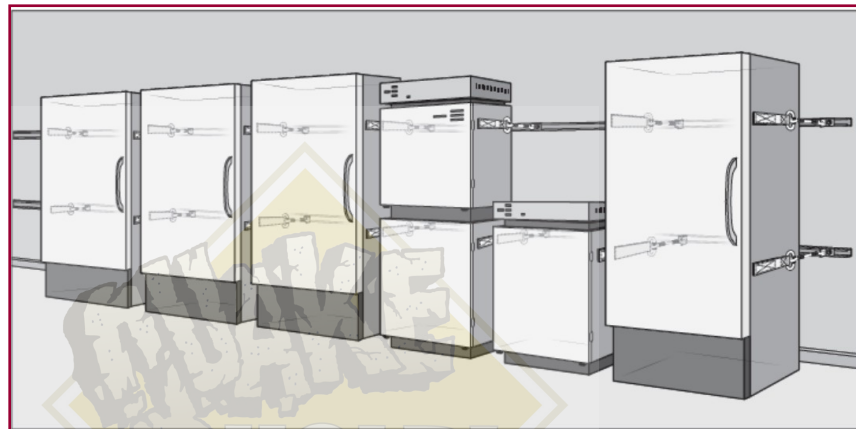

Freezer Farm Solutions

FREEZER ISLAND

Center Island
Constructed with
Double UniStrut
Frame

Sturdy Double
Reinforced
Frame Construc-
tion for Multiple
Freezer Styles

Straps Installed
Prior to Populat-
ing Freezers



800 959 4053
4 Offices to Serve you!



Freezer Farm Solutions

CRYO STORAGE ISLAND

Straps Use Velcro™ Adhesives and Have Quick Disconnect Buckles

Large Freezers are Secured with 2 Straps on Each Side Due to Weight and Higher Center of Gravity.



The Industry Leader
in Earthquake Fastening.



800 959 4053
4 Offices to Serve you!



OSHPD Solutions

**Exclusive
Manufacturer
and Certified
Installer for
Revco-Thermo
Seismic
Bracing**

OEM Launch
Fall 2013



The Industry Leader
in Earthquake Fastening.



**Removable Slide-Out Allows
For Easy Service and Calibration**

800 959 4053
4 Offices to Serve you!



Custom Fastening Solutions

MARBLE SCALE TABLE

Thumb Lock™
T-6 Fasteners
Adhere Table To
Upright With An
Epoxy Adhesive.

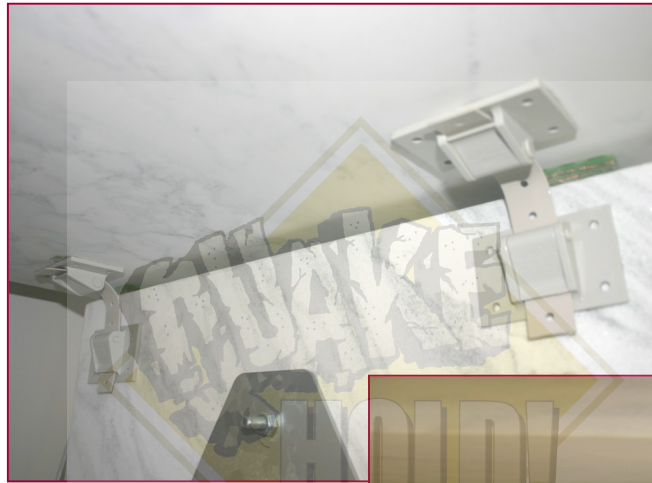

Cable Wraps
Around Table
Support Pipe
and Secured
Into Wall Strut



INDUSTRIAL
The Industry Leader
in Earthquake Fastening.

STACKED INCUBATORS

Ganged with 2"
x 3" Stainless
Steel Plates in
4 Locations

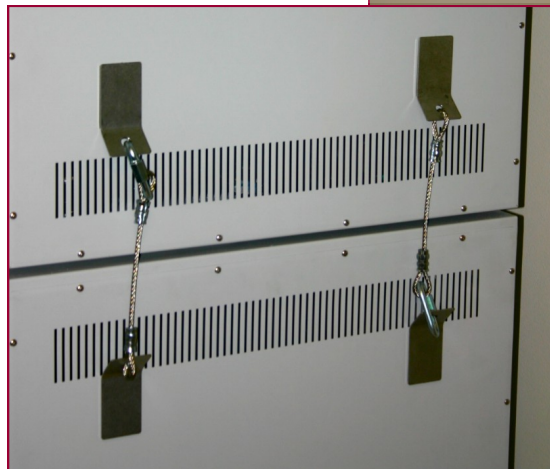

800 959 4053
4 Offices to Serve you!



Vivarium Solutions

Solutions Available for Clean Room, BSL, Positive and Negative Pressure Rooms

Typical Items:

Bio-Safety Cabinets

Centrifuges

Animal Cages

Mobile Racks

Counter Top Equipment



Custom-Fabricated Nets, Bars and Straps Are Constructed To Meet Various Height Requirements and Weight Options. Prevent Objects from Toppling Above or at Eye-Level

(Also, See Page 16)

800 959 4053
4 Offices to Serve you!



UCSD Shake Table



QuakeHold! was selected to participate in the World's largest shake table experiment constructed to improve all components of hospital and laboratory safety during and after an earthquake. We were responsible for populating the building with upright freezers, deli coolers, refrigerators, upright hoods, countertop equipment and also furnish a lifestyle living room with household furnishings. **QuakeHold!** fastened many of the items with our OSHPD systems as well as our other non OSHPD methods for countertop or wall mounting. The seismic shaking was rated at up to a 200 year event with severe shaking in excess of two minutes. All fastened items performed above our expectations and we experienced no failures. Those items that were left unsecured toppled over and were destroyed in the shaking.

Elevators, stairwells, structural columns and large sections of sheet rock were destroyed in the shaking. We learned many valuable lessons that will make the hospitals of the future safer for all.

To view our YouTube footage of the simulations go to www.quakeholdindustrial.com and click on the UCSD shake table.



UCSD Shake Table

SET UP FOR TESTING

(300+ Cameras, Seismic Sensors, GPS Monitoring, Physical Inspections and Documentation After Each Event, Mercalli Intensity Scale, Securing Methods, 5 Shake Scenarios Conducted)

Minus 80 Freezers

Deli Cooler

Refrigerator

Centrifuges

Metro Racks

Flam Cabinet

Laboratory Items

Bookcases

File Cabinets

Countertop Lab Equipment

TV's

Wall Mounted Shelving

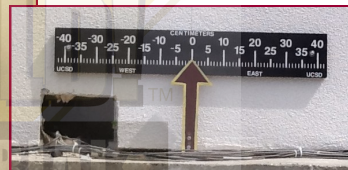

The Industry Leader in Earthquake Fastening.

800 959 4053
4 Offices to Serve you!



Tested · Approved

UCSD Results

MULTIPLE SHAKE EVENTS

Live Earthquake Simulation Demonstrates That Secured items Survived Intact and Unsecured items Toppled.



Watch Progression of Unsecured Items Toppling



The Industry Leader
in Earthquake Fastening.



Items Secured with QuakeHold! Industrial Products withstand Severe Shaking!

Actual Screenshots of the Footage Seen Here:
www.quakeholdindustrial.com
Click on the UCSD Shake Table.

UCSD Inspections

MULTIPLE SHAKE EVENTS

5 Story Building Experienced Severe Damage

Uninhabitable Red Tagged

QUAKEHOLD PREVAILED!

Without Our Mitigation Techniques and Fastening Solutions, Items Topped and Broke.

Elevator Door Askew



1st Flr Structural Damage

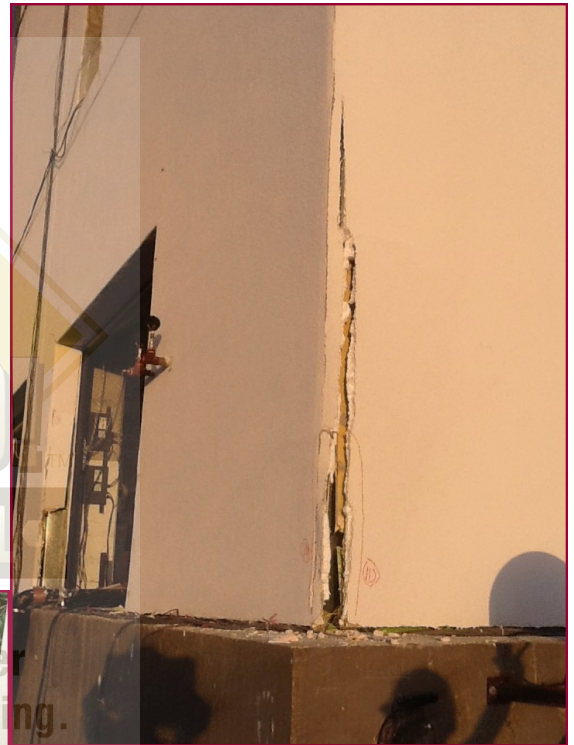

Inspectors Assess Damage



Patient Bed Overturned



Toppled TV and Other Objects